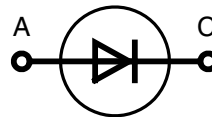
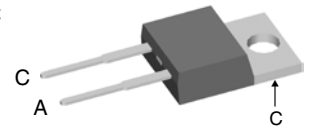

Fast Recovery Epitaxial Diode (FRED)

$I_{FAV} = 11\text{ A}$
 $V_{RRM} = 1200\text{ V}$
 $t_{rr} = 50\text{ ns}$

V_{RSM}	V_{RRM}	Type
V	V	
1200	1200	DSEI 12-12A

TO-220 AC

A = Anode, C = Cathode

Symbol	Conditions	Maximum Ratings		
I_{FRMS}	$T_{VJ} = T_{VJM}$	25	A	
I_{FAVM} ①	$T_C = 100^\circ\text{C}$; rectangular, $d = 0.5$	11	A	
I_{FRM}	$t_p < 10\ \mu\text{s}$; rep. rating, pulse width limited by T_{VJM}	150	A	
I_{FSM}	$T_{VJ} = 45^\circ\text{C}$;	$t = 10\text{ ms}$ (50 Hz), sine	75	A
		$t = 8.3\text{ ms}$ (60 Hz), sine	80	
	$T_{VJ} = 150^\circ\text{C}$;	$t = 10\text{ ms}$ (50 Hz), sine	65	A
		$t = 8.3\text{ ms}$ (60 Hz), sine	70	
I^2t	$T_{VJ} = 45^\circ\text{C}$;	$t = 10\text{ ms}$ (50 Hz), sine	28	A^2s
		$t = 8.3\text{ ms}$ (60 Hz), sine	27	
	$T_{VJ} = 150^\circ\text{C}$;	$t = 10\text{ ms}$ (50 Hz), sine	21	A^2s
		$t = 8.3\text{ ms}$ (60 Hz), sine	20	
T_{VJ}		-40...+150	$^\circ\text{C}$	
T_{VJM}		150	$^\circ\text{C}$	
T_{stg}		-40...+150	$^\circ\text{C}$	
P_{tot}	$T_C = 25^\circ\text{C}$	78	W	
M_d	mounting torque	0.4...0.6	Nm	
Weight	typical	2	g	

Features

- International standard package JEDEC TO-220 AC
- Planar passivated chips
- Very short recovery time
- Extremely low switching losses
- Low I_{RM} -values
- Soft recovery behaviour
- Epoxy meets UL 94V-0

Applications

- Antiparallel diode for high frequency switching devices
- Anti saturation diode
- Snubber diode
- Free wheeling diode in converters and motor control circuits
- Rectifiers in switch mode power supplies (SMPS)
- Inductive heating and melting
- Uninterruptible power supplies (UPS)
- Ultrasonic cleaners and welders

Advantages

- High reliability circuit operation
- Low voltage peaks for reduced protection circuits
- Low noise switching
- Low losses
- Operating at lower temperature or space saving by reduced cooling

Symbol	Conditions	Characteristic Values		
		typ.	max.	
I_R	$V_R = V_{RRM}$	$T_{VJ} = 25^\circ\text{C}$	250	μA
	$V_R = 0.8 \cdot V_{RRM}$	$T_{VJ} = 25^\circ\text{C}$	150	μA
	$V_R = 0.8 \cdot V_{RRM}$	$T_{VJ} = 125^\circ\text{C}$	4	mA
V_F	$I_F = 12\text{ A}$	$T_{VJ} = 150^\circ\text{C}$	2.2	V
		$T_{VJ} = 25^\circ\text{C}$	2.6	V
V_{T0}	For power-loss calculations only		1.65	V
r_T	$T_{VJ} = T_{VJM}$		46.2	$\text{m}\Omega$
R_{thJC}			1.6	K/W
R_{thCH}		0.5		K/W
R_{thJA}			60	K/W
t_{rr}	$I_F = 1\text{ A}$; $-di/dt = 50\text{ A}/\mu\text{s}$; $V_R = 30\text{ V}$; $T_{VJ} = 25^\circ\text{C}$	50	70	ns
I_{RM}	$V_R = 540\text{ V}$; $I_F = 12\text{ A}$; $-di_F/dt = 100\text{ A}/\mu\text{s}$ $L \leq 0.05\ \mu\text{H}$; $T_{VJ} = 100^\circ\text{C}$	6.5	7.2	A

① I_{FAVM} rating includes reverse blocking losses at T_{VJM} . $V_R = 0.8 \cdot V_{RRM}$, duty cycle $d = 0.5$
 Data according to IEC 60747

IXYS reserves the right to change limits, test conditions and dimensions.

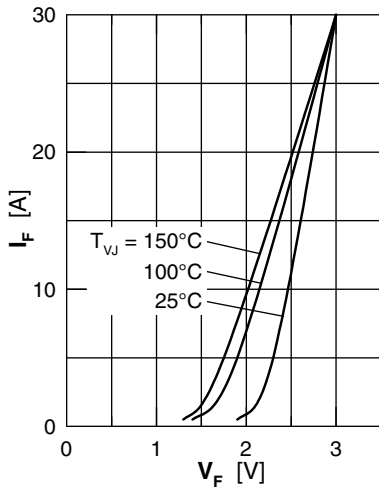

Fig. 1 Forward current versus voltage drop

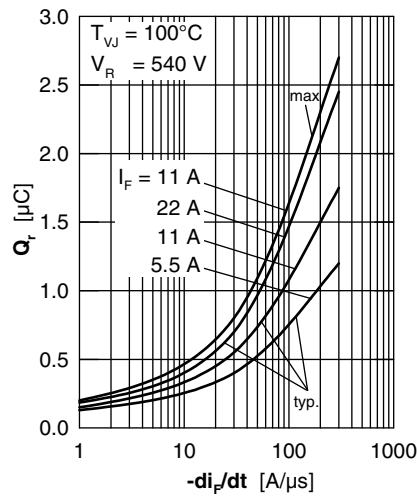

Fig. 2 Recovery charge versus $-di_F/dt$

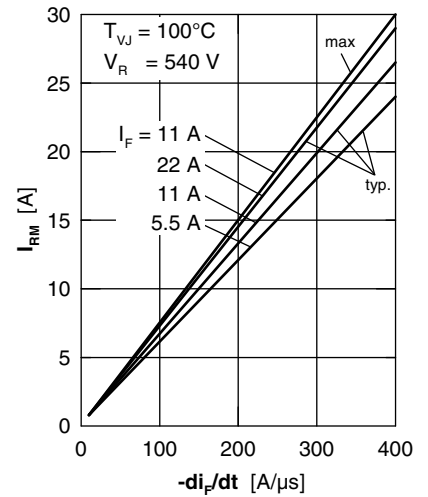

Fig. 3 Peak reverse current versus $-di_F/dt$

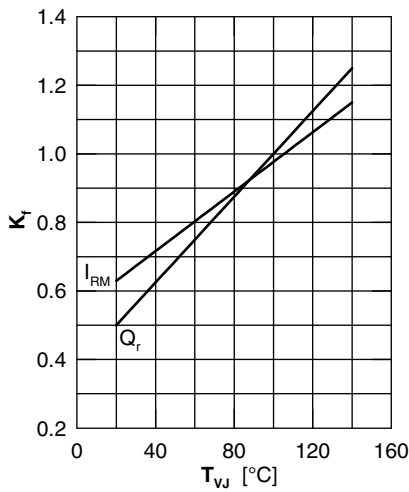

Fig. 4 Dynamic parameters versus junction temperature

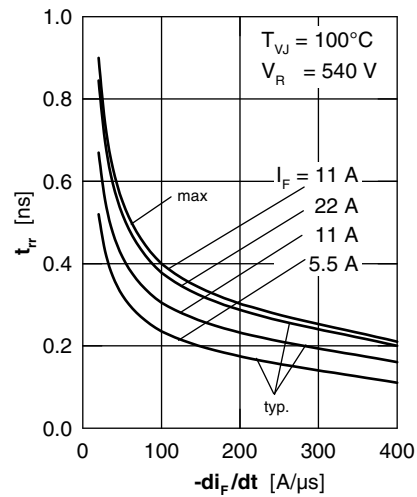

Fig. 5 Recovery time versus $-di_F/dt$

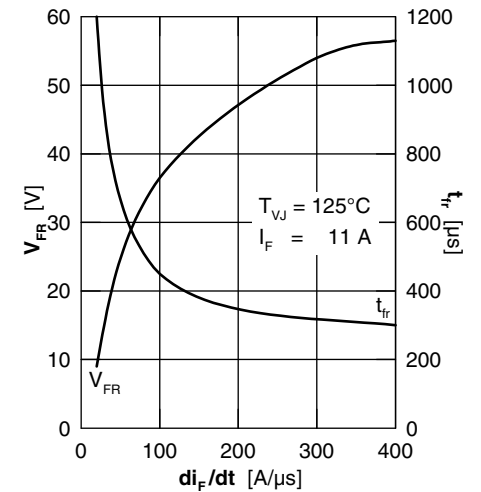

Fig. 6 Peak forward voltage versus di_F/dt

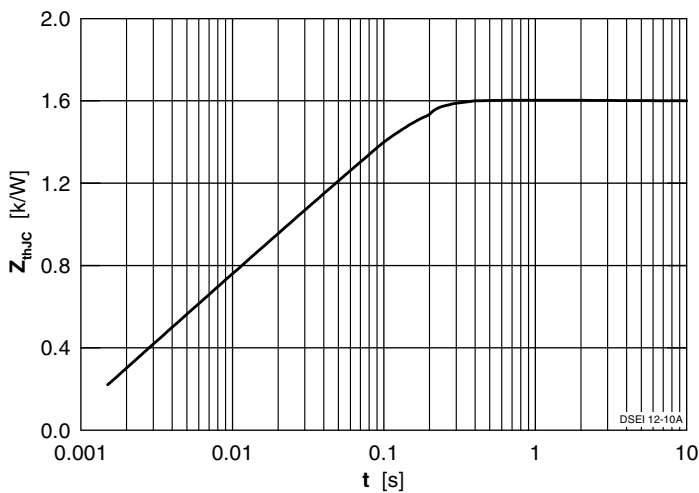
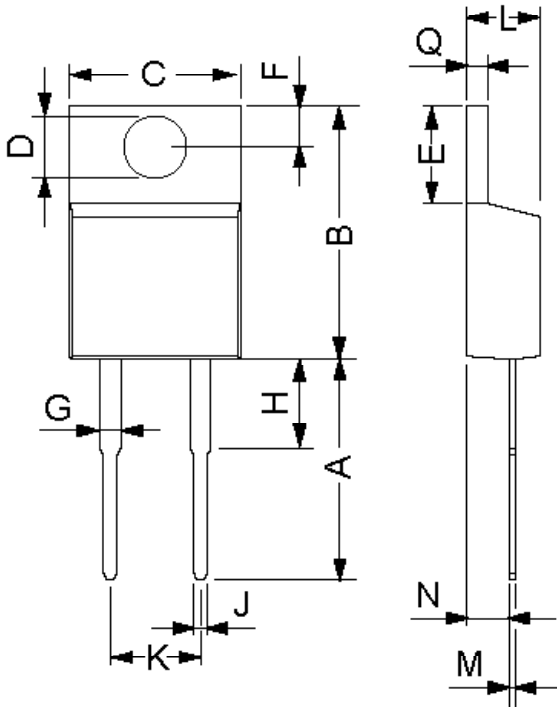

Fig. 7 Transient thermal resistance junction to case

Dimensions TO-220 AC



Dim.	Millimeter		Inches	
	Min.	Max.	Min.	Max.
A	12.7	14.73	0.5	0.58
B	14.23	16.51	0.56	0.65
C	9.66	10.66	0.38	0.42
D	3.54	4.08	0.139	0.161
E	5.85	6.85	0.23	0.27
F	2.54	3.42	0.1	0.135
G	1.15	1.77	0.045	0.07
H	-	6.35	-	0.25
J	0.64	0.89	0.025	0.035
K	4.83	5.33	0.19	0.21
L	3.56	4.82	0.14	0.19
M	0.51	0.76	0.02	0.03
N	2.04	2.49	0.08	0.115
Q	0.64	1.39	0.025	0.055

Mouser Electronics

Authorized Distributor

Click to View Pricing, Inventory, Delivery & Lifecycle Information:

[IXYS:](#)

[DSEI12-12A](#)